

Read this manual carefully before use, and retain it for future reference.

Lesen Sie dieses Handbuch vor der Verwendung sorgfältig durch, und bewahren Sie es für die spätere Verwendung auf.

Lisez attentivement ce manuel avant toute utilisation et conservez-le pour pouvoir le consulter ultérieurement.

Lea detenidamente este manual antes de usar el producto y consévelo para futuras consultas.

Leggere attentamente il presente manuale prima dell'uso del dispositivo e conservarlo per ogni riferimento futuro.

Перед использованием внимательно изучите это руководство. Сохраните его, оно может понадобиться вам в дальнейшем.

제품 사용 전에 본 설명서를 자세히 읽고 잘 보관하세요.

اقرأ هذا الدليل بعناية قبل الاستخدام واحتفظ به للرجوع إليه مستقبلاً.

Product Overview

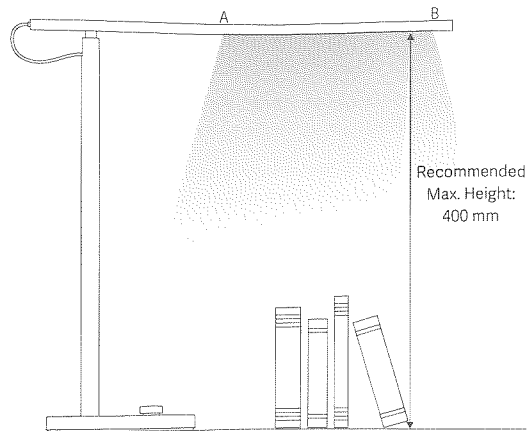

Thank you for choosing the Mi LED Desk Lamp 1S. This lamp is equipped with high-quality LEDs and features a professional optical design using a natural light mixing algorithm to deliver a uniform lighting experience. This lamp is intended for use in studies, bedrooms, and other indoor areas. Under normal usage conditions, the lamp should be positioned so that the direction of the lamp head (indicated by points A and B) is parallel to the desktop. When the light emitting surface is level, the vertical distance between it and the desktop is 400 mm.

Using the Lamp

Connect to Power Supply

Plug the power cable into the charging port at the base and connect the adapter to a power supply.

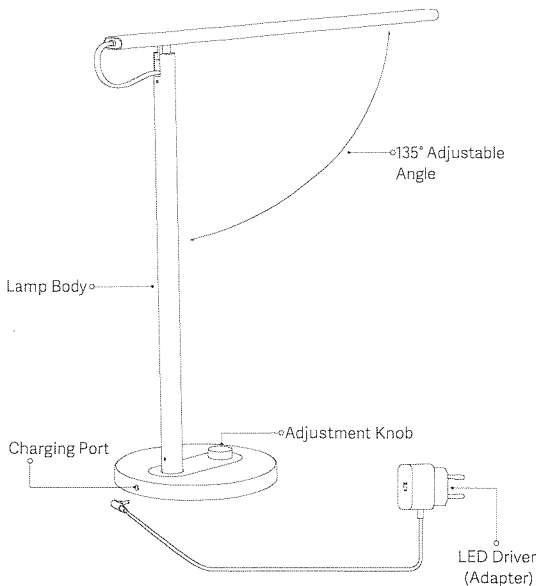

Button Instructions

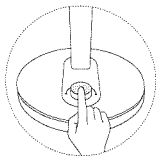

Press down on the knob once to turn the lamp on or off.

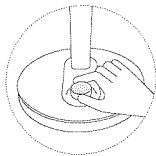

Turn the knob to adjust the lamp's brightness.

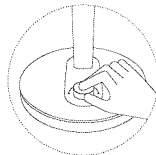

Hold the knob down and turn it to adjust the lamp's color temperature.

Connecting with Mi Home / Xiaomi Home App

This product works with Mi Home / Xiaomi Home app*. Control your device, and interact it and other smart home devices with Mi Home / Xiaomi Home app.

Scan the QR code to download and install the app. You will be directed to the connection setup page if the app is installed already. Or search "Mi Home / Xiaomi Home" in the app Store to download and install it.

Open Mi Home / Xiaomi Home app, tap "+" on the upper right, and then follow prompts to add your device.

* The app is referred to as Xiaomi Home app in Europe (except for Russia). The name of the app displayed on your device should be taken as the default.



Note: The version of the app might have been updated, please follow the instructions based on the current app version.

Apple HomeKit Smart Control

1. Open the Home app on your iPhone or iPad.
2. Tap "Add Accessories" and follow the instructions in the app to scan the QR code on the product base, or enter the 8-digit setup code above the QR code to grant the Apple Home app access.

* Make sure a Wi-Fi network with Internet access is available (this product does not support 5G networks).



To control this HomeKit-compatible accessory, it is recommended that you use iOS 9.0 or above.

The HomeKit setup code is listed on the product base, do not lose it. After restoring factory settings, you will need the HomeKit setup code again to add the accessory.

iPad and iPhone are the trademarks of Apple Inc., and they are registered in the United States and other countries.

Link a Lamp with Google Assistant

Add the Mi Home / Xiaomi Home service to the Google Assistant app, to control devices connected to Mi Home / Xiaomi Home from Google Assistant.

1. Tap  in the Google Assistant app, search for "Mi Home / Xiaomi Home", tap "Link", and sign in with your Xiaomi account.
2. Tap  in Settings > Home control to add a device, and follow the on-screen instructions. Once the accounts are linked, you can control the Lamp from Google Assistant.

Link a Lamp with Amazon Alexa

Add the Mi Home / Xiaomi Home skill to the Amazon Alexa app, to control devices connected to Mi Home / Xiaomi Home from Amazon Alexa.

1. Tap  in the Amazon Alexa app, then tap "Skills & Games", search for "Mi Home / Xiaomi Home", select the correct skill and tap "Enable". Then sign in with your Xiaomi account.
2. After successfully linking the accounts, tap DISCOVER DEVICES to add the device, and follow the on-screen instructions. Once the accounts are linked, you can control the Lamp from Amazon Alexa.

Note: The name (Mi Home or Xiaomi Home) varies by selected language or regions.

Factory Reset

The Reset hole is at the bottom of the lamp base. When powered on, insert a straightened tool into the hole for 5 seconds, and let go when the lamp starts to breathe. The Reset completes when the breathing stops.

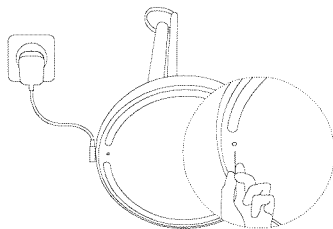

* Restore factory settings to connect to a new network.

Specifications

Model: MJTD01SYL

Operating Temperature: -10°C to 35°C

Operating Humidity: 0-85% RH

Service Life: Approx. 25000 h

Color Rendering Index: Ra90

Power Factor: 0.5

Bedside Lamp Input: 12 V $\text{---} 0.8\text{A}$ $\text{---} \oplus$

Rated Input Power: 9 W (Lamp + LED Driver)

Rated Input: 220-240 V-50/60 Hz 0.45 A

Wireless Connectivity: Wi-Fi IEEE 802.11 b/g/n 2.4 GHz

Compatible with: Android 4.4 or iOS 9.0 and above

Operating Frequency: 2412-2472 MHz (Wi-Fi) 2402-2480 MHz (BT)

Maximum Output Power: 17.91 dBm (Wi-Fi) 5.76 dBm (BT)

Product Features



Color
Temperature
Adjustment



Brightness Adjustment



Flicker Free



Low Blue
Light
Content



Scheduled
On/Off



Foldable Design



135° Adjustable Angle



High Color
Rendering
Index



Reading Mode



PC Mode



Child Mode



Focus Mode



Mi Home/
Xiaomi
Home App*



HomeKit Control





Turn-off Delay



Firmware
Update

Warning

- Suitability for use "indoors", the related ambient temperature is 35°C.
- Please use the power resource correctly in the door.
- If in any doubt, consult a qualified electrician.
- Do not put the luminaire on the inclined plane.
-  For household use only.
-  Class III Luminaire.
- If the power cord is damaged, it must be replaced by the manufacturer or a qualified service engineer to avoid any risks to safety.
- For non-user replaceable light sources:
"The light source contained in this luminaire shall only be replaced by the manufacturer or his service agent or a similar qualified person."
- Do not disassemble the product. The light-emitting diode may cause damage to your eyes.

CE EU Declaration of Conformity

Hereby, Qingdao Yeelink Information Technology Co., Ltd., declares that the radio equipment type MJTD01SYL is in compliance with Directive 2014/53/EU. The full text of the EU declaration of conformity is available at the following internet address:
<https://www.mi.com/en/service/support/declaration.html>.

WEEE Disposal and Recycling

All products bearing this symbol are waste electrical and electronic equipment (WEEE as in directive 2012/19/EU) which should not be mixed with unsorted household waste. Instead, you should protect human health and the environment by handing over your waste equipment to a designated collection point for the recycling of waste electrical and electronic equipment, appointed by the government or local authorities. Correct disposal and recycling will help prevent potential negative consequences to the environment and human health. Please contact the installer or local authorities for more information about the location as well as terms and conditions of such collection points.

